

IT - ISTRUZIONI DI MONTAGGIO
EN - ASSEMBLY INSTRUCTIONS
DE - MONTAGEANLEITUNG
FR - INSTRUCTIONS DE MONTAGE

G26221C

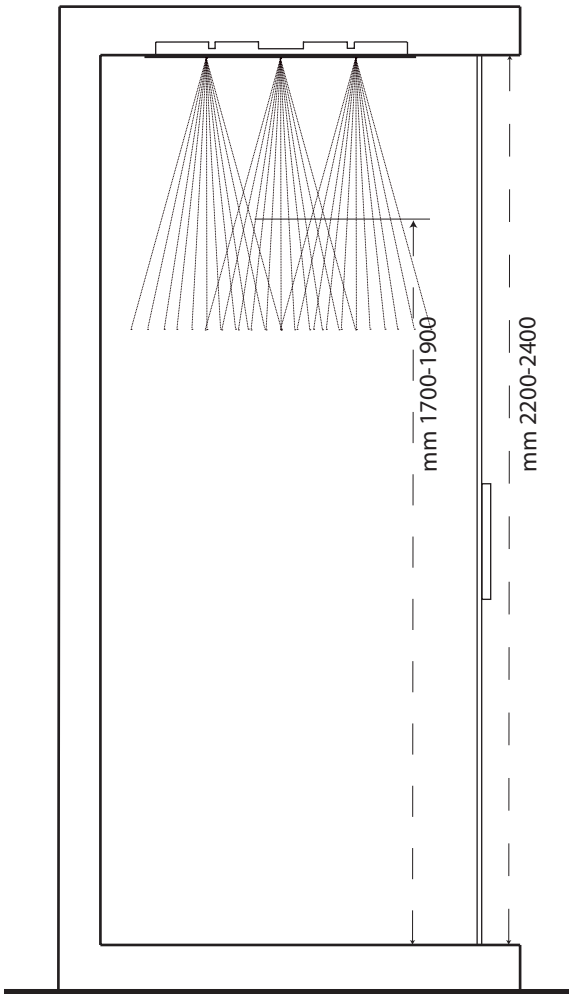

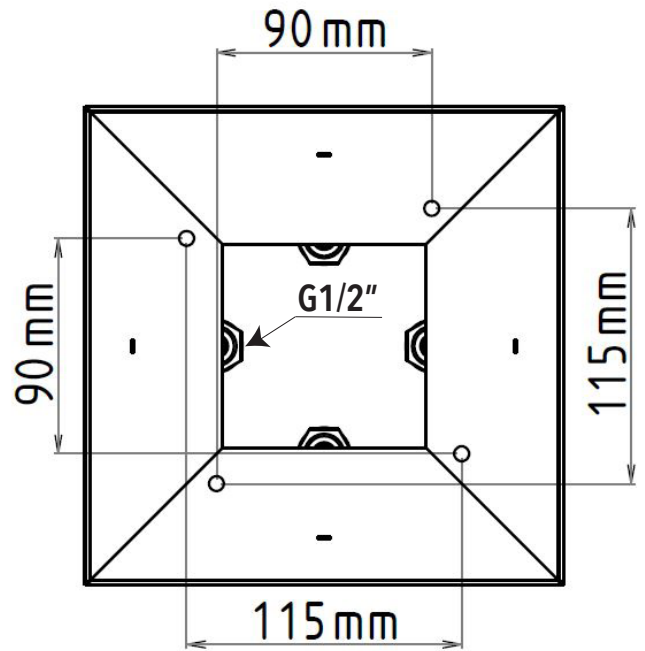
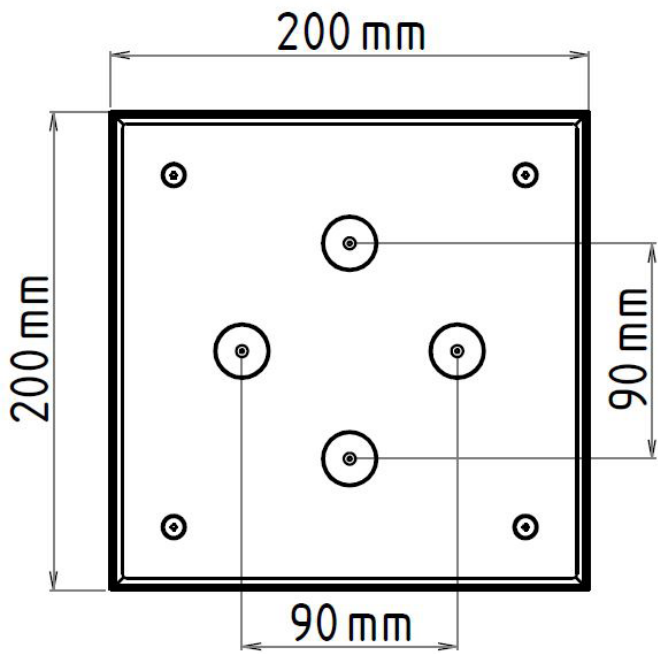

MAX 70° C
BEST 38/40° C



MIN 1 Bar
MAX 5 Bar
BEST 3 Bar

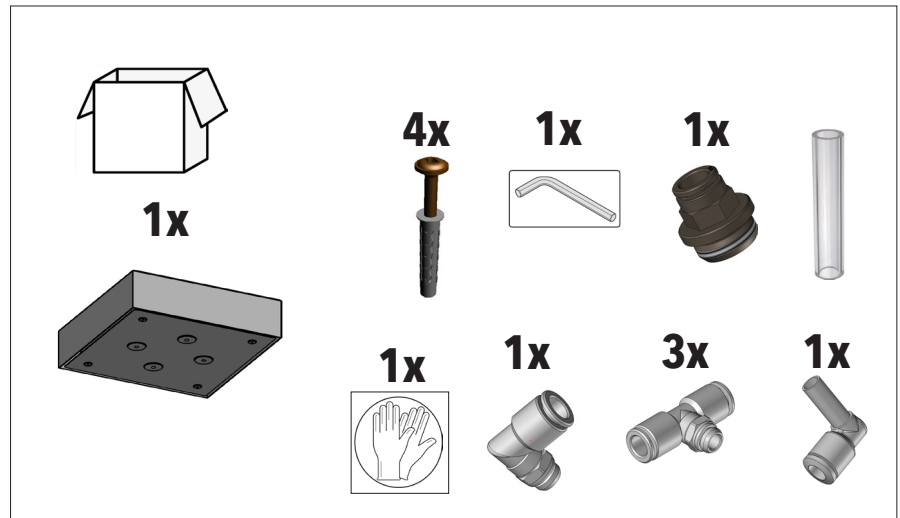

10'



IT - L'apparechio deve essere installato da personale abilitato ai sensi e per l'effetto delle leggi in vigore.

EN - According to the law, all installation and maintenance operations require a qualified person.

DE - Das Gerät muss von qualifiziertem Personal gemäß den geltenden Gesetzen installiert werden.

FR - L'appareil doit être installé par du personnel qualifié conformément et pour l'effet des lois en vigueur.

1

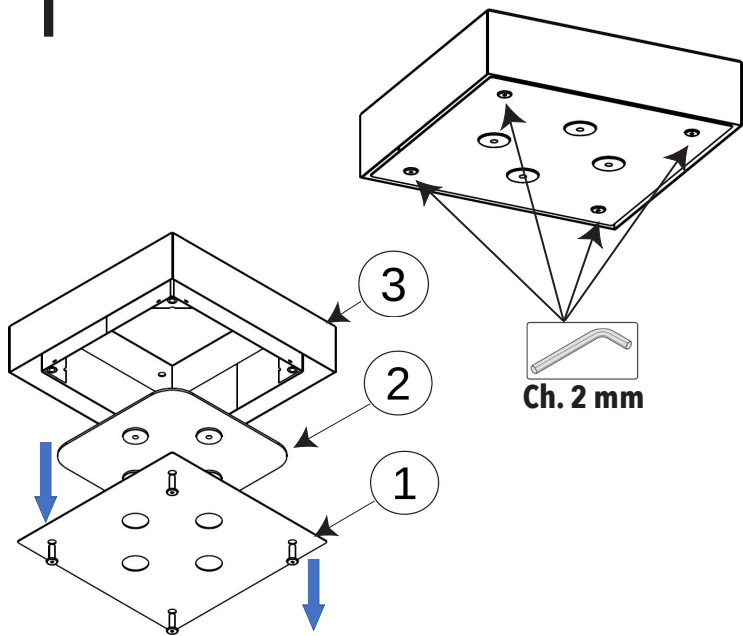

2

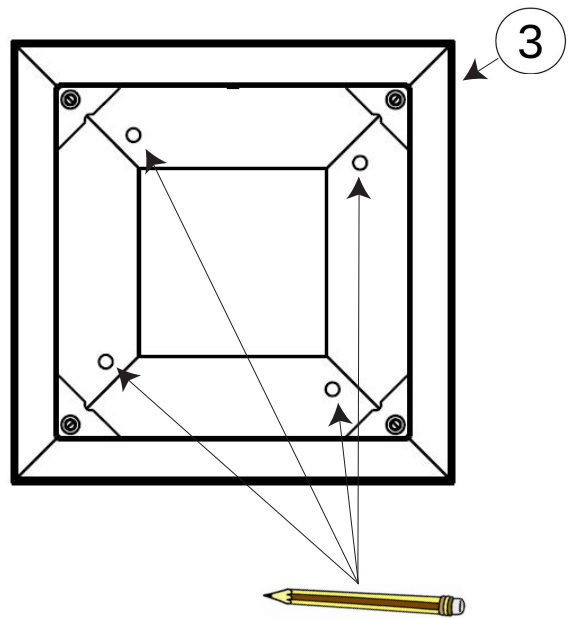

3

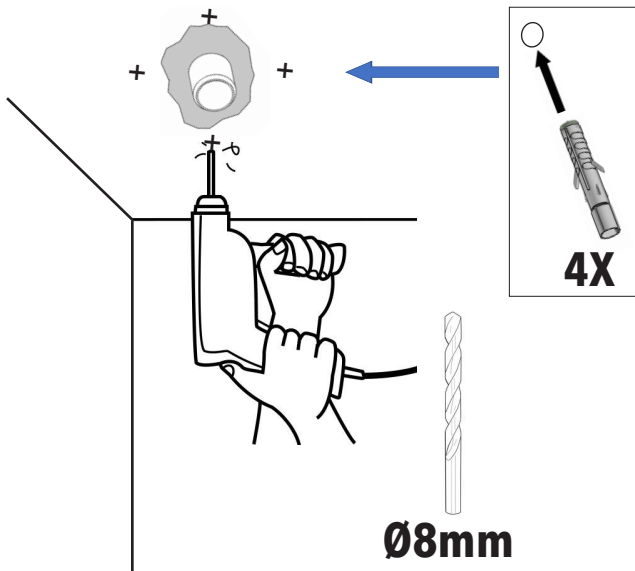

4

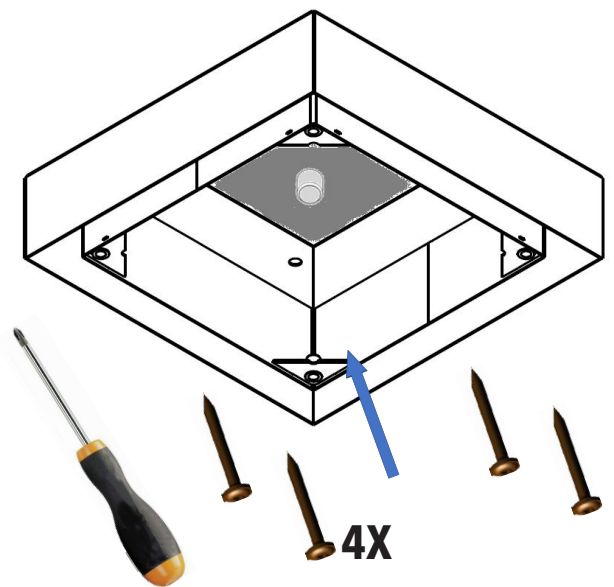

5

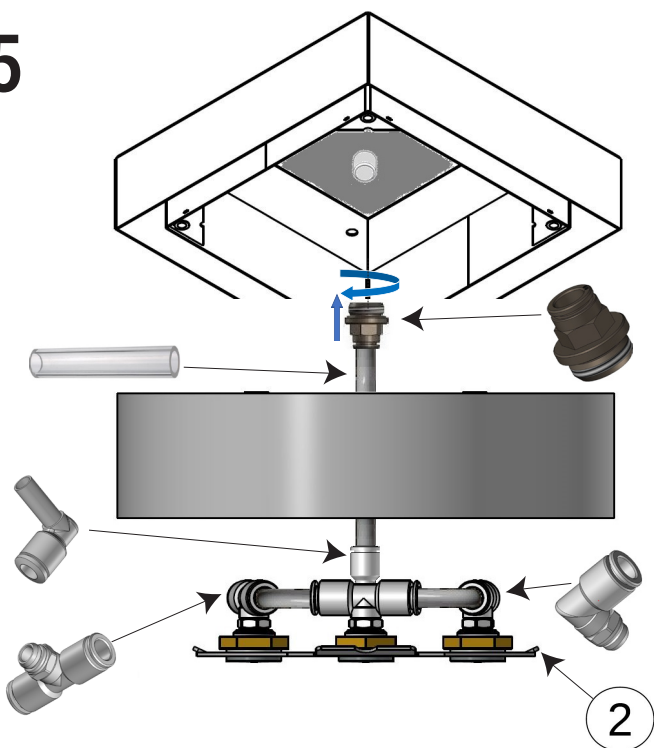

6

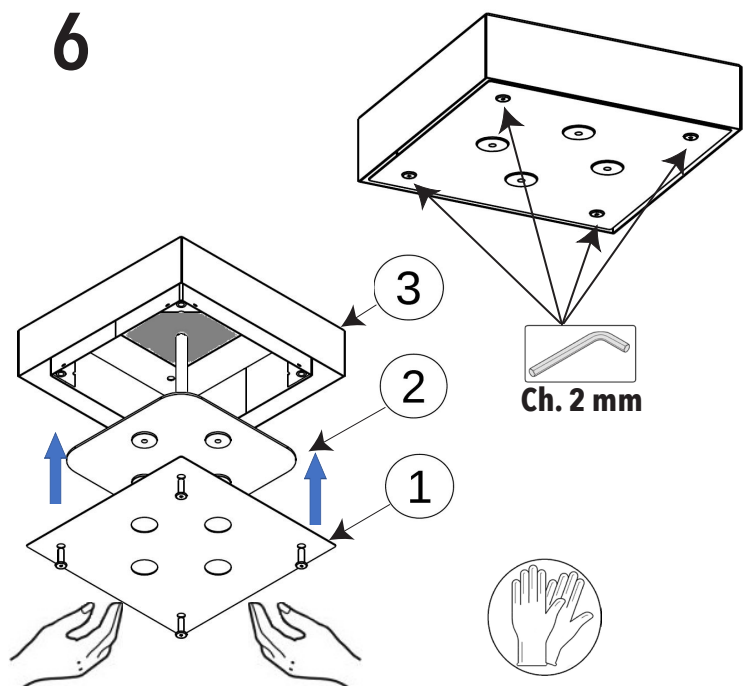



DO NOT USED DETERGENT

CH₃CH₂OH

HCL

H₂SO₄

CL

H₃PO₄

OR OTHER CORROSIVE



IT - LA GARANZIA DEL PRODOTTO NON COPRE

L'utilizzo improprio.

L'errata predisposizione dell'impianto idraulico.

Danni causati da depositi di calcare o altre impurità.

Detergenti non adatti.

EN - NOT COVERED BY PRODUCT CARE

Not correct use.

Incorrect setup of the hydraulic system.

Water impurities or limestone deposits.

Improper detergents.

DE - DIE PRODUKTGARANTIE GILT NICHT

Die falsche Verwendung

Die falsche Anordnung des Hydrauliksystems.

Schäden durch Kalkablagerungen oder andere

Verunreinigungen.

Ungeeignete Reiniger.

FR - LA GARANTIE DU PRODUIT NE COUVRE PAS

Utilisation incorrecte.

La mauvaise disposition du système hydraulique.

Dommages causés par des dépôts de calcaire ou

d'autres impuretés.

Nettoyants inappropriés.



IT - DUE ANNI DI GARANZIA DEL PRODOTTO

Contro i difetti o vizi di fabbricazione.

EN - TWO-YEAR PRODUCT CARE

Against defects of fabrication.

DE - ZWEI JAHRE LANG PRODUKTGARANTIE

Gegen Mängel oder Herstellungsfehler

FR - GARANTIE DE PRODUITS DE DEUX ANSO

Contre les défauts de fabrication.

IT - ATTENZIONE: Si declina ogni responsabilità relativa ad eventuali inesattezze contenute in queste istruzioni dovute ad errori di trascrizione.

EN - WARNING: We decline all responsibility for eventual inaccuracy contained in the instructions due to transcript errors.

DE - ACHTUNG: Wir lehnen jede Verantwortung für Ungenauigkeiten in diesen Anleitung aufgrund von Transkriptionsfehlern ab.

FR - ATTENTION: Nous déclinons toute responsabilité pour toute inexactitude contenue dans ces instructions en raison d'erreurs de transcription.



Via Mattei, 14
25060 Collebeato (BS) - Italy

Phone: +39 030 26 80 854
Fax: +39 030 65 93 335
Email: info@artisitaly.com